



DIE VERSTECKDOSE®



WWW.DIEVERSTECKDOSE.DE
WWW.HIDDENOCKET.COM

1. BEDIENUNG

HANDLING | FAIRE FONCTIONNER | OPERANDO | MANEGGIO | OPERATIE

ÖFFNEN
OPEN
OUVERTURE
OPENING
APERTURA

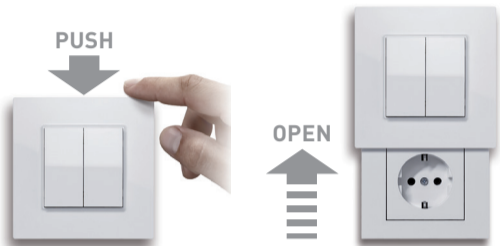

SCHLIESSEN
CLOSE
FERMER
SLUITEN
CHIUDERE
CERRAR



Art. Nr. 0039080 | VF9673 | Stand 06.2019 Technische Änderungen vorbehalten. TCS AG - PF 1251 - D-39307 Genthin - Deutschland / Germany
Hue, Friends of Hue, and all related logos are trademarks of Signify Holding. Philips is a trademark of Koninklijke Philips N.V.

2. MONTAGE

ASSEMBLY | MONTAGE | MONTAJE | MONTAGGIO | SAMENSTEL

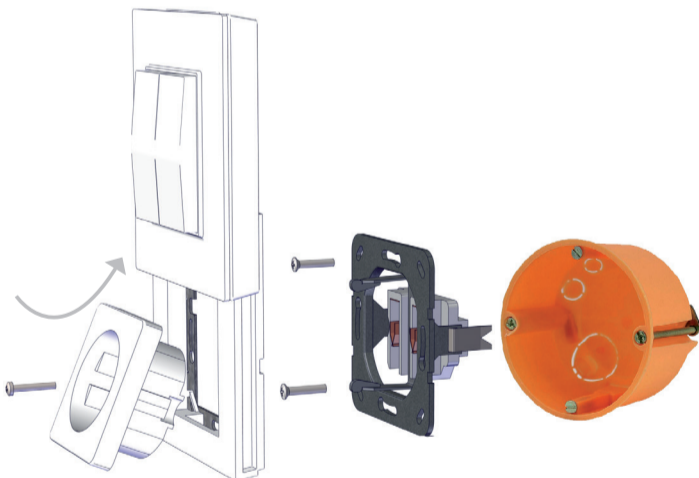

3. VERDRÄHTUNG

WIRING | CÂBLAGE | ALAMBRADO | CABLAGGIO | BEDRADING



UMRÜSTUNG AUSSCHLIESSLICH FÜR AUS-SCHALTUNG ZULÄSSIG.
MODIFICATION ONLY PERMITTED FOR OFF CIRCUIT.



CONVERSION AUTORISÉE UNIQUEMENT POUR UN CIRCUIT OFF.
SÓLO SE PERMITE LA CONVERSIÓN PARA UN CIRCUITO DE APAGADO.
CONVERSIONE CONSENTITA SOLO PER UN CIRCUITO OFF.



Umrüstung ausgeschlossen für:

1. Verkabelung mit Klingeldraht, 2. Verkabelung mit nur zwei Adern ohne Schutzleiter

Modification excluded for:

1. wiring with bell wire, 2. wiring with only two wires without protective conductor

Rénovation exclue pour:

1. Câblage avec fil à cloche, 2. Câblage avec seulement deux fils sans conducteur de protection

Omzetting uitgesloten voor:

1. Bedrading met belkabels met belkabels, 2. Bekabeling met slechts twee draden zonder beschermingsgeleider

Reequipamiento excluido para:

1. Cableado con alambre de campana, 2. Cableado con solo dos hilos sin conductor de protección

Retrofitting esclusi per:

1. Cablaggio con cavo a campana, 2. Cablaggio con solo due fili senza conduttore di protezione

3.1

OHNE ABZWEIGDOSE
WITHOUT JUNCTION BOX
SANS BOÎTE DE JONCTION
ZONDER VERDEELDOOS
SENZA SCATOLA DI DERIVAZIONE
SIN CAJA DE CONEXIONES

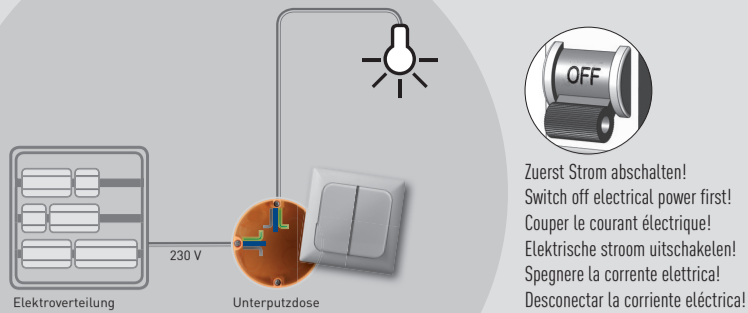

Zuerst Strom abschalten!
Switch off electrical power first!
Couper le courant électrique!
Elektrische stroom uitschakelen!
Spegner la corrente elettrica!
Desconectar la corriente eléctrica!

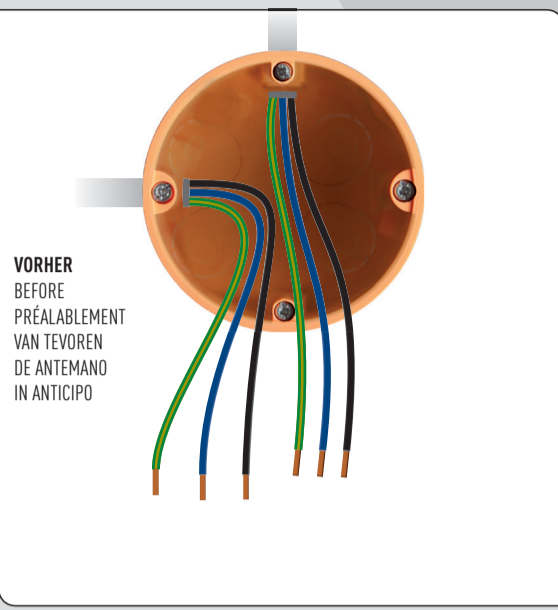

VORHER
BEFORE
PRÉALABLEMENT
VAN TEVOREN
DE ANTEMANO
IN ANTICIPO

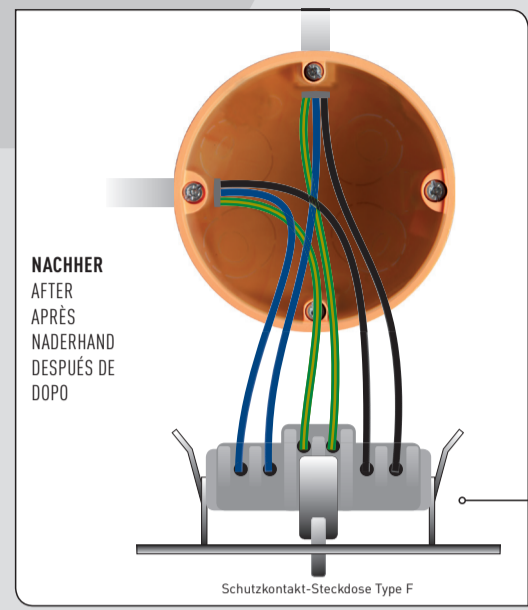

NACHHER
AFTER
APRÉS
NADERHAND
DESPUÉS DE
DOPO

3.2

MIT ABZWEIGDOSE
WITH JUNCTION BOX
AVEC BOÎTE DE JONCTION
MET VERDEEL-DOOS
CON SCATOLA DI DERIVAZIONE
CON CAJA DE CONEXIONES

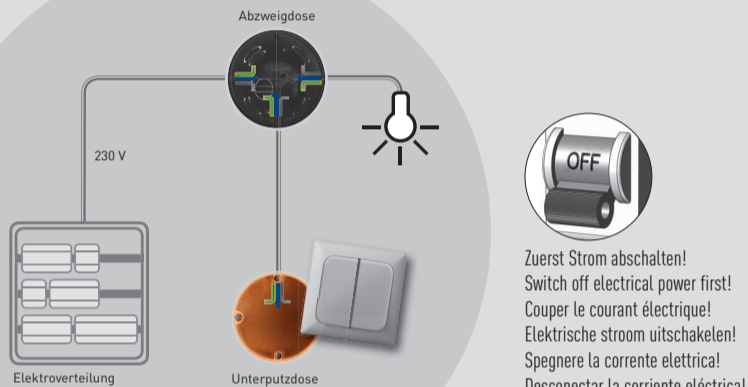

Zuerst Strom abschalten!
Switch off electrical power first!
Couper le courant électrique!
Elektrische stroom uitschakelen!
Spegner la corrente elettrica!
Desconectar la corriente eléctrica!

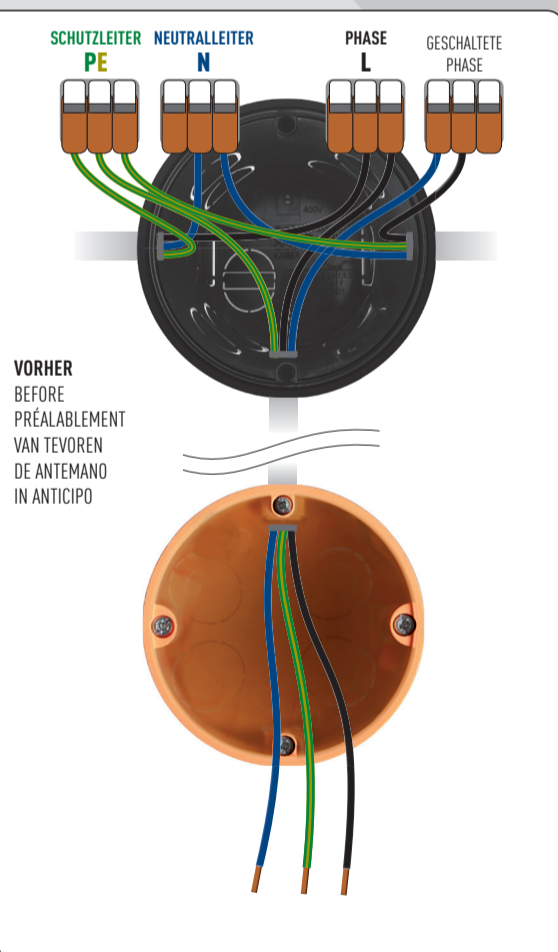

VORHER
BEFORE
PRÉALABLEMENT
VAN TEVOREN
DE ANTEMANO
IN ANTICIPO

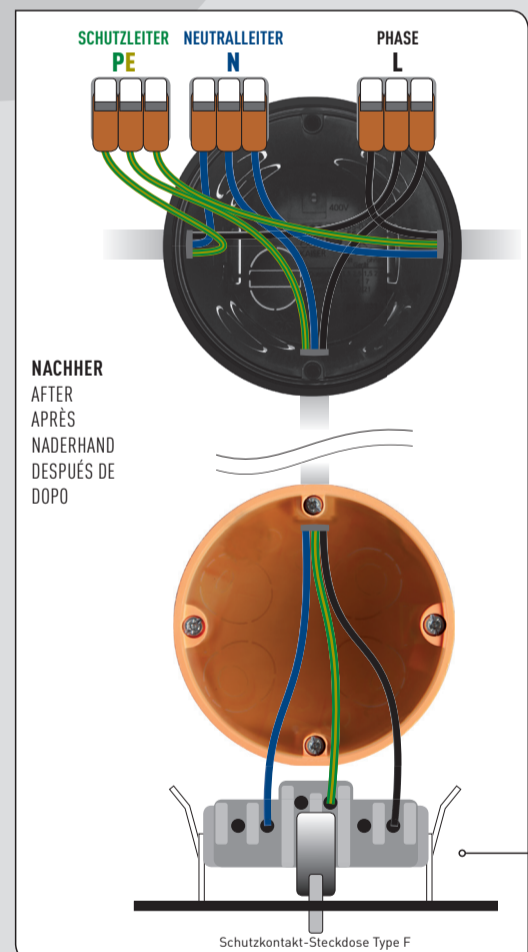

NACHHER
AFTER
APRÉS
NADERHAND
DESPUÉS DE
DOPO

4. KONFIGURATION

CONFIGURATION | PARAMÉTRAGE | CONFIGURACIÓN | CONFORMAZIONE | CONFIGURATIE

Erfordert die Hue Bridge (v2) und die Philips Hue App (v3.2) für Android oder iOS. Mehr dazu unter: meethue.com. Stellen Sie sicher, dass die Hue Lampe stromversorgt und angeschaltet ist. Nur so kann sie vom Hue System gesteuert werden.

Requires a Philips Hue Bridge (v2) and Philips Hue App (v3.2) for Android or iOS for initial setup. Learn more on: meethue.com. Please ensure Hue lamp is plugged in and always switched ON. The Hue lamp can only be controlled by the Hue system when the light is powered on.

Nécessite le Hue Bridge (v2) et l'application Philips Hue (v3.2) pour Android ou iOS. Pour plus d'informations: meethue.com. Veuillez vous assurer que la lampe Hue est branchée et toujours allumée. Il ne peut être contrôlé par le système Hue que lorsque le voyant est allumé.

Vereist de Hue Bridge (v2) en de Philips Hue App (v3.2) voor Android of iOS. Voor meer informatie: meethue.com. Zorg ervoor dat de Hue lamp is aangesloten en altijd is ingeschakeld. De Hue lamp kan alleen door het Hue-systeem worden aangestuurd als het licht is ingeschakeld.

Richiede l'Hue Bridge (v2) e l'applicazione Philips Hue (v3.2) per Android o iOS. Per maggiori informazioni: meethue.com. Assicurarsi che la lampada Hue sia inserita e sempre accesa. Può essere controllato dal sistema Hue solo quando la luce è accesa.

Requiere el Hue Bridge (v2) y la aplicación Philips Hue App (v3.2) para Android o iOS. Para más información: meethue.com. Asegúrese de que la lámpara Hue esté enchufada y siempre encendida. Sólo puede ser controlado por el sistema Hue cuando la luz está encendida.

Sie werden in der Hue App durch die Konfiguration geführt:

1. Zubehör einrichten 2. Friends of Hue Schalter hinzufügen 3. TCS Hidden socket

You will be guided through the configuration in the Hue app:

1. Accessory setup 2. add a Friends of Hue switch 3. TCS Hidden socket

Vous serez guidé à travers la configuration dans la Hue app:

1. Montage des accessoires 2. jouter un interrupteur Friends of Hue 3. TCS Hidden socket

U wordt door de configuratie in de Hue app geleid:

1. Accessoires installeren 2. Friends of Hue Schakelaar toevoegen 3. TCS Hidden socket

Se le guiará a través de la configuración en la Hue app:

1. Accesorios para el sistema 2. Agregar interruptor Friends of Hue 3. TCS Hidden socket

Sarete guidati attraverso la configurazione in Hue app:

1. Montaje de accesorios 2. Agregar interruptor Friends of Hue 3. TCS Hidden socket

SCHUTZKONTAKT-STECKDOSE

SOCKET OUTLET
PRISE DE TERRE DE CONTACT
AARCONTACTDOOS
PRESA DI CONTATTO DI TERRA
TOMA DE TIERRA



ART. VS02-01010000
(SOCKET TYPE F)

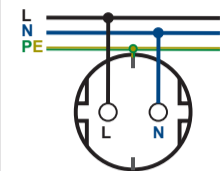

ART. VS02-01040000
(SOCKET TYPE J)

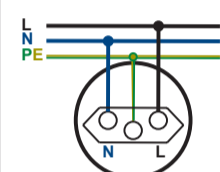

ART. VS02-01050000
(SOCKET TYPE E)

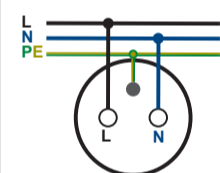

ART. VS02-01060000
(SOCKET TYPE G)

